

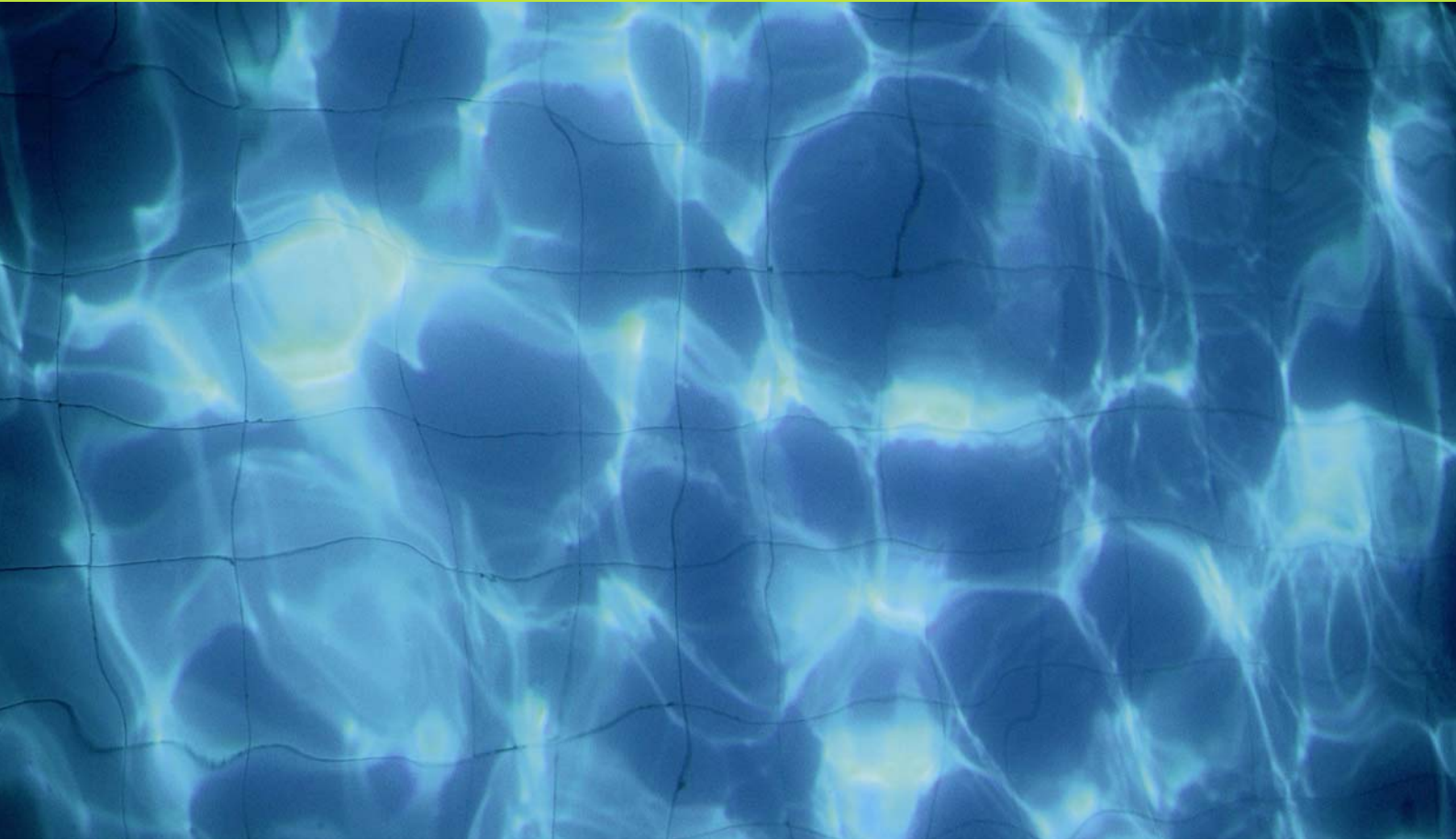

eyeheight



# canalettoSDi

SDI colour corrector

**user manual**

# Table of Contents

1 System Overview .....	4
2 Installation .....	5
2.1 Connections to a canalettoSDi.....	5
2.2 Associated Equipment for the canalettoSDi.....	5
3 Control Panel .....	6
4 Operation .....	8
4.1 Manual control of the canalettoSDi .....	8
4.2 Automation Control of the canalettoSDi .....	8
4.3 Operational Menus for the canalettoSDi .....	9

# Table of Figures

Figure 1 - Typical Connections.....	5
Figure 2 - evolutionDT Control Panel .....	7

# I System Overview

This manual describes the function of the canalettoSDi processing card. The canalettoSDi is a simple cost effective colour correction system, which will give individual control of R, G, and B Gain, lifts and Gamma. The system also inherently legalises the signal enabling the user to make full use of the colour correction without fear of the resultant picture being rejected by broadcasters.

The canalettoSDi is a unit that accepts one standard SDI video input, and has one SDI output, program out. The main features are :-

- Full 10 bit processing.
- Simple individual control of RGB gain, lift and master gamma.
- Overall luma, chroma gain and black level adjustment.
- Overall hue correction.
- Gamut legalization as standard with EBU R103-2000 set up mode.
- Adjustable legalisation levels.
- Highly effective luma overshoot and undershoot suppression.
- EDH re-insertion.
- 6 user memories.
- Integrated “safe area generator”.

## 2 Installation

### 2.1 Connections to a canalettoSDi

The diagram below shows the typical connections to the canalettoSDi.

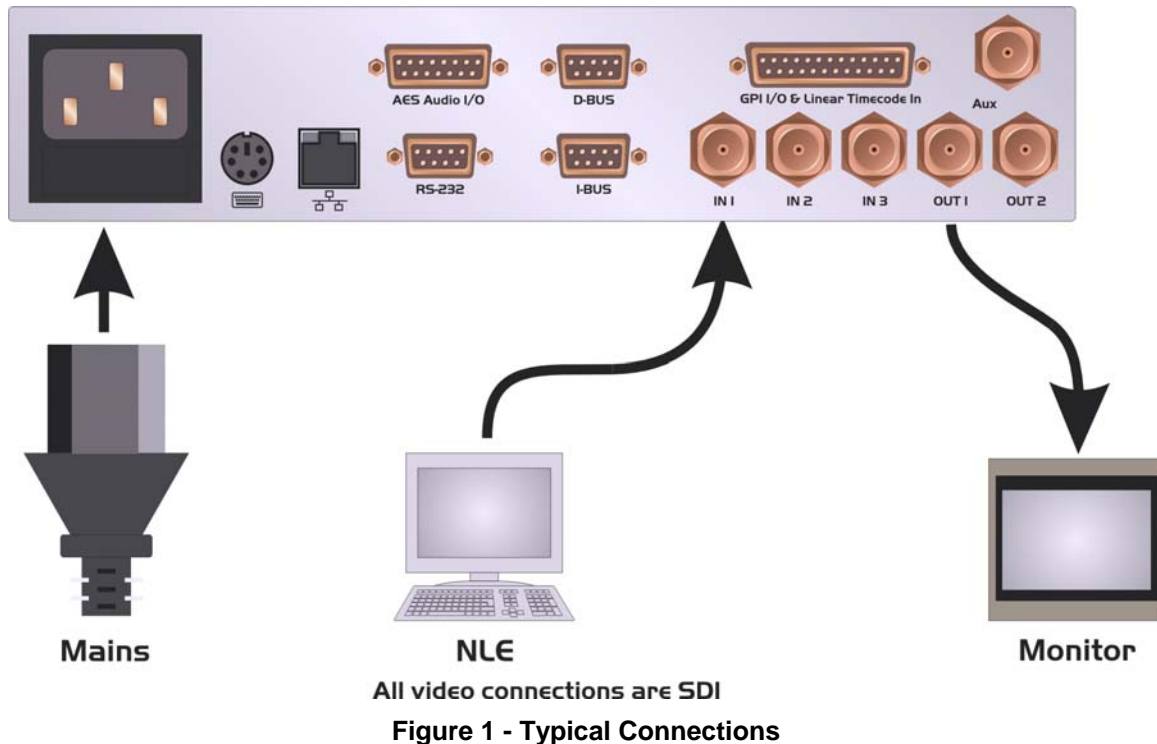

IN1 is the SDI input. OUT1 is the main SDI legalised output.

### 2.2 Associated Equipment for the canalettoSDi

The canalettoSDi in the evolutionDT platform is fully self-contained. The evolutionDT can optionally be rack mounted in with 1 or 2 units in a 19" rack using the optional FF-6 rack mounting. This is a factory-installed option and should be ordered with the product. Rack mounted units should be supported with suitable chassis supports.

# 3 Control Panel

Figure 3 shows the control panel of the evolutionDT platform.

## 1 - Power/Status LED

Green – Normal operation

Green Flashing - Version Information Display

Orange – Product is initialising

Flashing Red – Product is in Field Reprogramming Mode

## 2 - Menu Display/Button (1 of 4)

Displays Menu Information. The colour of the menu button indicates the function.

Green – adjustment menu. Pressing the menu or using the associated digipot(6) will adjust the menu value.

Yellow – information menu, no adjustment possible.

Blue – navigation menu. Pressing the button will take you up or down the menu hierarchy.

Red – multiple variable menu. Pressing the button will “open” the menu assigning one digipot(6) to each variable. The active LED(5) will light above the digipots associated with each variable.

## 3 - Next Menu Button

Within a layer of the menu hierarchy there may be more than four menus and where this is the case the “next” button will illuminate to show that further menus are available. Pressing the “next” button moves you to the next set of menus.

## 4 – Previous Menu Button

Within a layer of the menu hierarchy there may be more than four menus and where this is the case the “prev” button will illuminate to show that previous menus are available. Pressing the “prev” button moves you to the previous set of menus.

## 5 – Digipot Active LED (1 of 4)

Illuminates to indicate that the digipot below is active for adjustment of the associated menu variable.

## 6 – Digipot (1 of 4)

Allows for rapid adjustment of the associated menu variable.

## 7 – Next Device Button

It is possible to control more than one device from a single evolutionDT control panel. Where more than one device is assigned to the panel the “next dev” will move control to the next device in the device list.

In setup mode this button will pick up a free device and assign it to this panels device list. The button will flash to indicate that a free device is selected.

## 8 – Previous Device Button

Where more than one device is assigned to the panel the “prev dev” will move control to the previous device in the device list.

In setup mode this button will remove a device owned by this panel from this panels device list. The button will flash to indicate an owned device is selected.

### 9 – Info Button

This button displays all hardware, software and firmware version information for the currently selected product and this panel.

In setup mode where a free evolutionDT device is selected this button will flash indicating that the network address (box & slot) can be changed. Pressing this button will take you to the adjustment menus.

### 10 – Setup Button

Press and hold this button for four seconds to enter setup mode.

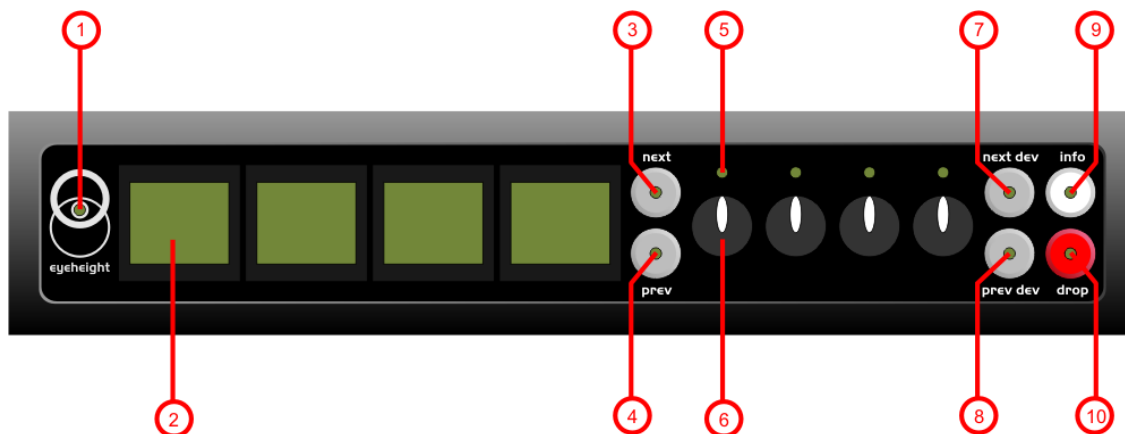

Figure 2 - evolutionDT Control Panel

# 4 Operation

## 4.1 Manual control of the canalettoSDi

The canalettoSDi is controlled using a set of MENUS. Each of these menus contains up to 3 parameters that are adjusted using the rotary digipots. The Menus define all of the adjustable operational parameters in the canalettoSDi.

See chapter 3 Control Panel Operation for details of the control panel operation.

See section 3 of this chapter for the full list of menus.

## 4.2 Automation Control of the canalettoSDi

Automation of the evolutionDT products is achieved either via the RS232 port (currently not implemented) or via the I-Bus Port using an optional DG-9 (RS232 to I-Bus dongle). Automation control of the canalettoSDi is performed using the geNETics Automation Protocol.

Genetics protocol is described in detail in the “geNETics User Guide” section titled “Automation Protocol on the geNETics Platform”. The menu list in section 3 of this chapter contains the data information for the protocol.

Please refer to the “User guide for the DG-9 eyeheight dongle and set-up software.

## 4.3 Operational Menus for the canalettoSDi

### Menu 00-03: Top level controls



Menu Num.	Heading	Automation	Function
0	Master	N/A	Pressing this button will select the MASTER control menus.
1	Grade	N/A	Pressing this button will select the Individual GRADE control menus.
2	Utils	N/A	Pressing this button will select the onboard utilities, such as the legaliser.
3	Memory	N/A	Pressing this button will select the memory control menus.

### Menu 04-07: Master controls



Menu Num.	Heading	Automation	Function
4	LUMA	N/A	Pressing this button will select the luma control menus.
5	CHROMA	N/A	Pressing this button will select the chroma control menus.
6	GAMMA	N/A	Pressing this button will select the gamma control menus.
7	BACK	N/A	Pressing this button will take the user back to the main menu.

**Menu 08-11: Luma control menu**

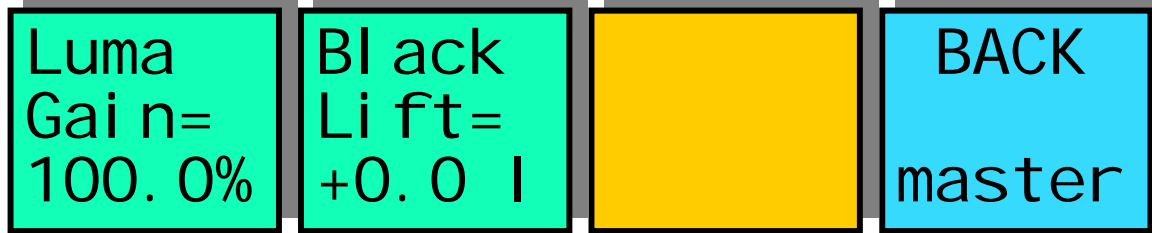

Menu Num.	Heading	Automation	Function
8	Luma Gain (0 – 199.7%)	0 to 511 default is 256 (=100.0%)	This option sets the Luma gain.
9	Black Lift (-29 – 28.9)	-254 to +255, default is 0	This option sets the black lift
10		N/A	none
11	Back	N/A	Pressing this button will take the user back to the master control menu

**Menu 12-15: Chroma control menu**

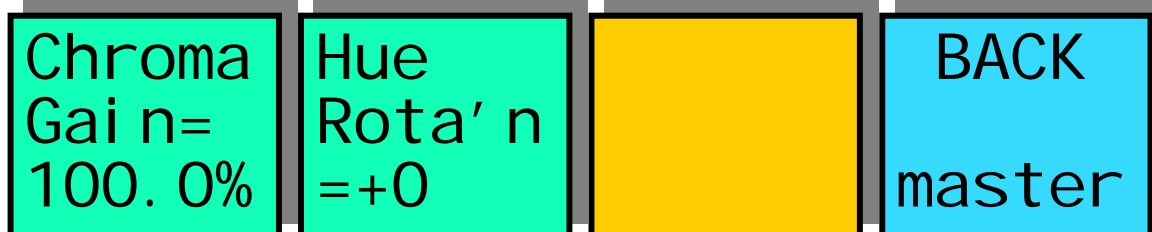

Menu Num.	Heading	Automation	Function
12	Chroma Gain (0 to 199.7%)	0 to 511 default is 256 (=100.0%)	This option sets the Chroma gain.
13	Hue Rota'n (-180 to +180)	-512 to +511 default is 0	This option sets the Hue rotation.
14		N/A	None
15	Back	N/A	Pressing this button will take the user back to the master control menu

**Menu 16-19: Grade control menu**

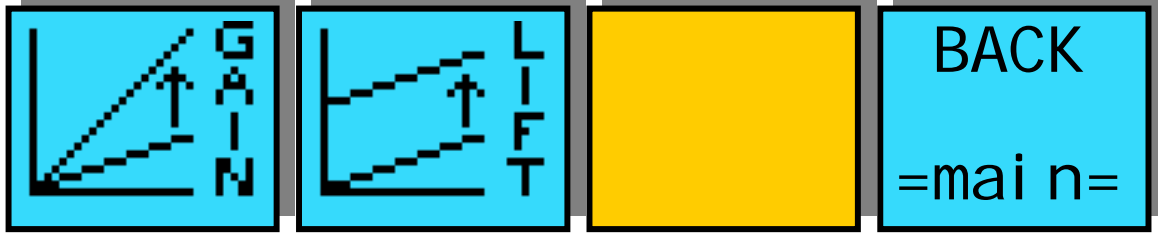

Menu Num.	Heading	Automation	Function
16	Gain menu	N/A	Pressing this button will select the grade gain control menu.
17	Lift menu	N/A	Pressing this button will select the grade lift control menu.
18		N/A	None
19	Back	N/A	Pressing this button will take the user back to the main menu

**Menu 20-23: Grade gain control menu.**

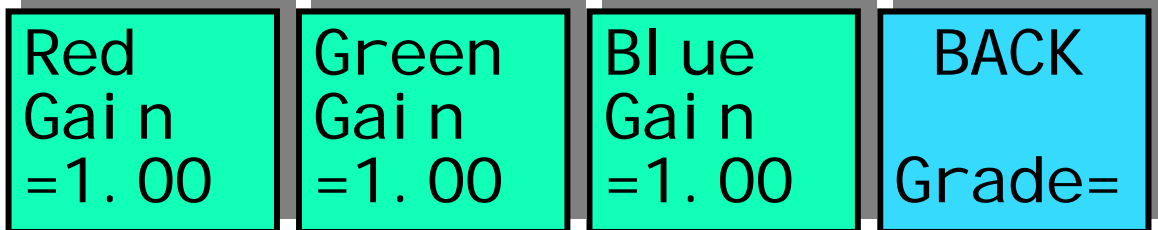

Menu Num.	Heading	Automation	Function
20	Red Gain 0 to 16	0 to 4096 default is 256 (=1.00)	This option sets the Red gain.
21	Green Gain 0 to 16	0 to 4096 default is 256 (=1.00)	This option sets the Green gain.
22	Blue Gain 0 to 16	0 to 4096 default is 256 (=1.00)	This option sets the Blue gain.
23	Back	N/A	Pressing this button will take the user back to the main menu

**Menu 24-27: Grade lift control menu.**

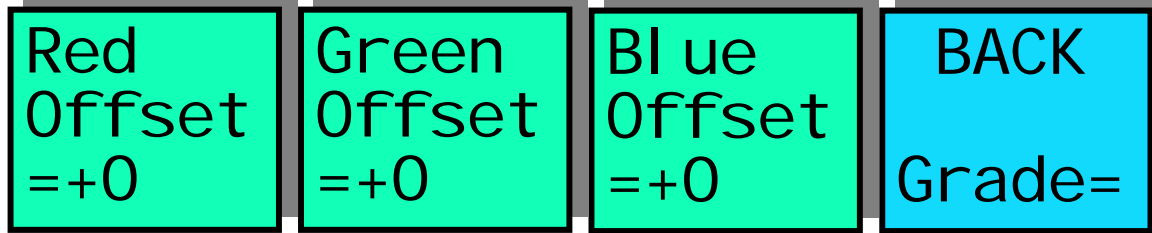

Menu Num.	Heading	Automation	Function
24	Red Offset -512 to +511	-512 to +511 default is 0	This option sets the Red offset.
25	Green Offset -512 to +511	-512 to +511 default is 0	This option sets the Green offset.
26	Blue Offset -512 to +511	-512 to +511 default is 0	This option sets the Blue offset.
27	Back	N/A	Pressing this button will take the user back to the grade control menu

**Menu 28-31: Utils control menu.**

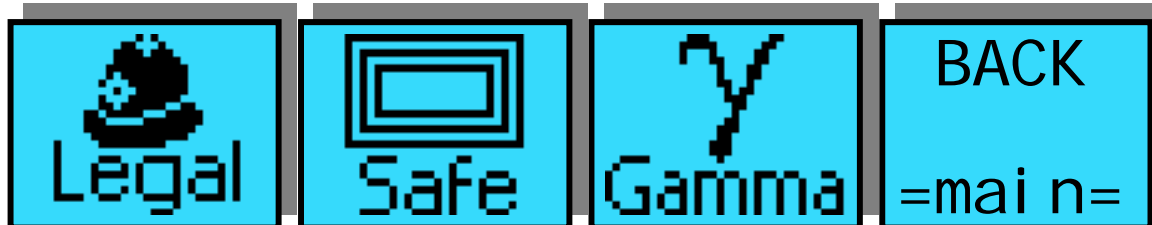

Menu Num.	Heading	Automation	Function
28	Legal menu	N/A	Pressing this button will select the legaliser control menu.
29	S.Area menu	N/A	Pressing this button will select the Safe Area Generator control menu. (Menus 72→75)
30	Gamma menu	N/A	Pressing this will select the Gamma control menus
31	Back	N/A	Pressing this button will take the user back to the main menu

### Menu 32-35: Legaliser control menu

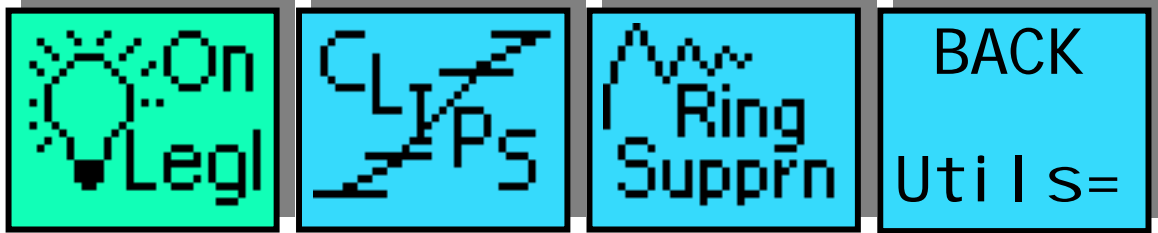

Menu Num.	Heading	Automation	Function
32	Legalr	0=Off,1=On Default is On	Pressing this will turn the legaliser on or off.
33	CLIP menu	N/A	Pressing this button will select the legaliser clip control menu.
34	RING menu	N/A	Pressing this button will select the legaliser ring control menu.
35	Back	N/A	Pressing this button will take the user back to the Utils menu

### Menu 36-39: Clip control menu

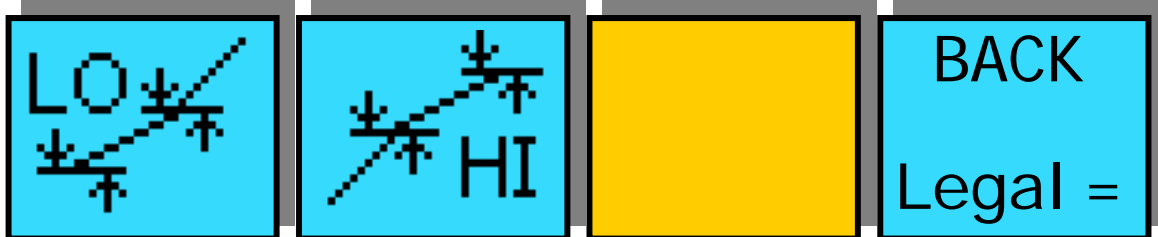

Menu Num.	Heading	Automation	Function
36	LOW Menu	-512 to +511 default is 0	This option sets the Red offset.
37	HIGH menu	-512 to +511 default is 0	This option sets the Red offset.
38		N/A	None
39	Back	N/A	Pressing this button will take the user back to the Legaliser control menu

**Menu 40-43: Low clip control menu.**



Menu Num.	Heading	Automation	Function
40	LoClip Level -7.1 to +50.8%	1 to 511, default is 64 (=0.0%)	This option sets the level of the low clip point.
41	LoKnee Level -7.1 to +50.8%	1 to 511, default is 64 (=0.0%)	This option sets the level of the low knee point.
42		N/A	None
43	Back	N/A	Pressing this button will take the user back to the Legaliser clip control menu

**Menu 44-47: High clip control menu.**



Menu Num.	Heading	Automation	Function
44	HiClip Level 50.9 to 109%	512 to 1022, default is 943 (=100%)	This option sets the level of the high clip point.
45	HiKnee Level 50.9 to 109%	512 to 1022, default is 943 (=100%)	This option sets the level of the high knee point.
46		N/A	None
47	Back	N/A	Pressing this button will take the user back to the Legaliser clip control menu

### Menu 48-51 Ring control menus

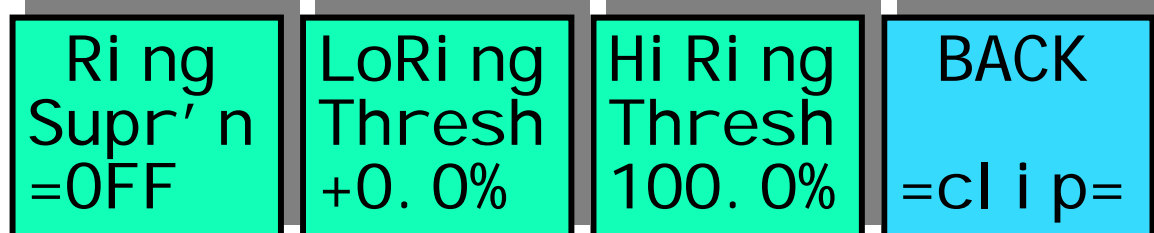

Menu Num.	Heading	Automation	Function
48	Ring Supr'n	0=Off, 1=Auto,2=Man Default is Off	Pressing this will select the mode of the ring suppression, off, automatic or manual.
49	LoRing Threshold -6.8 to +51.2%	0 to 511 default is 60 (-0.0%)	This option sets the level of the low ring threshold point.
50	HiRing Threshold 50.9% to 109%	512 to 1023 default is 944 (=100%)	This option sets the level of the high ring threshold point.
51	Back	N/A	Pressing this button will take the user back to the Legaliser clip control menu

### Menu 52-55: Memory Controls

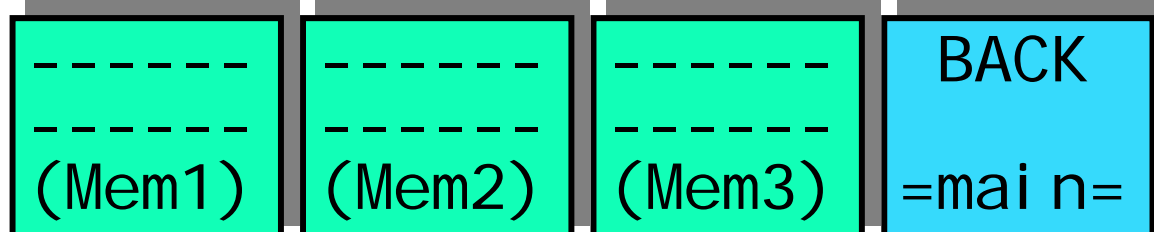

Menu Num.	Heading	Automation	Function
52	MEM1	1=Recall	Pressing this will recall Memory number 1. User Names can be programmed in to the memories using a keyboard. See "geNETics User guide", section "Giving product Memories names"
53	MEM2	1=Recall	Pressing this will recall Memory number 2.

54	MEM3	1=Recall	Pressing this will recall Memory number 3.
55	Back	N/A	Pressing this button will take the user back to the main menu

**Menu 56-59: Memory Controls**

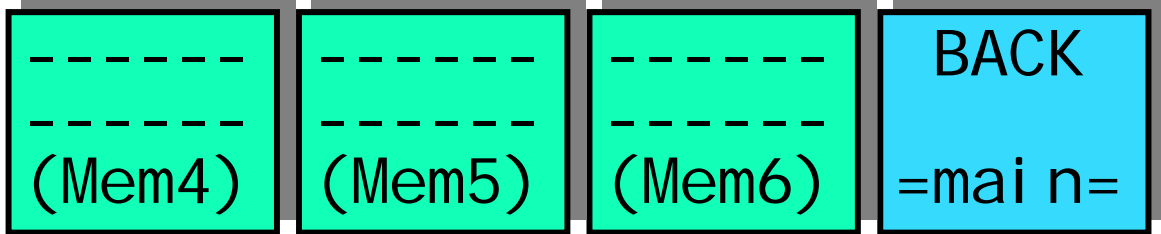

Menu Num.	Heading	Automation	Function
56	MEM4	1=Recall	Pressing this will recall Memory number 4.
57	MEM5	1=Recall	Pressing this will recall Memory number 5.
58	MEM6	1=Recall	Pressing this will recall Memory number 6.
59	Back	N/A	Pressing this button will take the user back to the main menu

**Menu 60-63: Memory Controls**

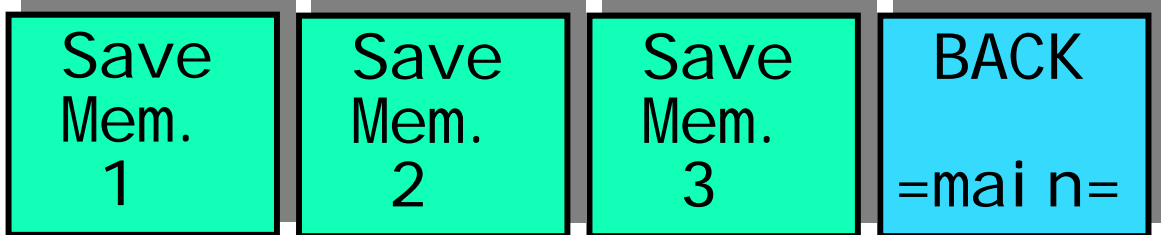

Menu Num.	Heading	Automation	Function
60	Save Mem. 1	1= Save	Pressing this will Save Memory number 1.
61	Save Mem. 2	1= Save	Pressing this will Save Memory number 2.
62	Save Mem. 3	1= Save	Pressing this will Save Memory number 3.

	Mem. 3		number 3.
63	Back	N/A	Pressing this button will take the user back to the main menu

**Menu 64-67: Memory Controls**

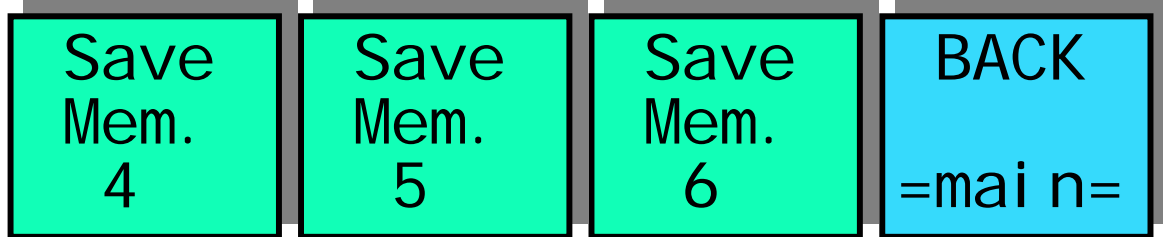

Menu Num.	Heading	Automation	Function
64	Save Mem. 4	1= Save	Pressing this will Save Memory number 4.
65	Save Mem. 5	1= Save	Pressing this will Save Memory number 5.
66	Save Mem. 6	1= Save	Pressing this will Save Memory number 6.
67	Back	N/A	Pressing this button will take the user back to the main menu

**Menu 68-71: Software version**

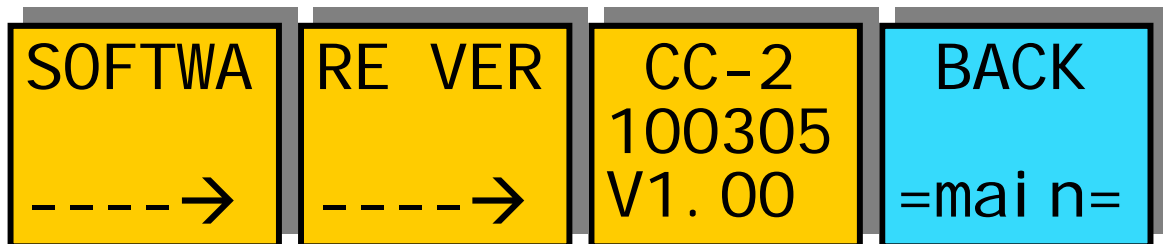

Menu Num.	Heading	Automation	Function
68		N/A	Info
69		N/A	Info
70	CC-2 103005 V1.00	N/A	Info, the top line is product identifier, the middle is the date the software was last changed, and the last line is the software version.
71	BACK	N/A	Pressing this button will take the user back to the main menu

### Menu 72-75: Top Level Controls



Menu Num.	Heading	Automation	Function
72	Set As Pow On Memory	1=save	Pressing this will save the current set up as the power on default.
73	Recall Pow On Memory	1=Recall	Pressing this will recall the power on default settings.
74	TOTAL RESET	1=Reset	Pressing this will reset the system.
75	BACK	N/A	Pressing this button will take the user back to the main menu

### Menu 76-79: Top Level Controls

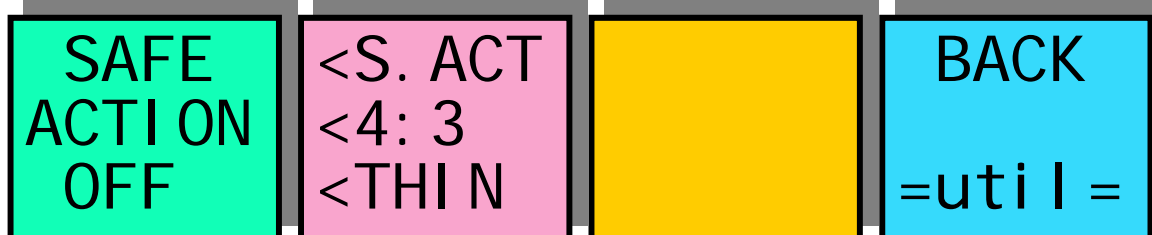

Menu Num.	Heading	Automation	Function
76	SAFE ACTION	0=on 1=off	This Switches on and off the currently selected area. Pressing the "Red" switch next to this one and adjusting the rotary digipots with the lighted green LED's chooses the Selected area.
77	None	          <b>Level "A"</b>	When this button is pressed to "Green". The Three-line display in the window indicates the three options, which can be changed by adjusting the three rotary digipots A, B and C.  <u>Digipot A</u> Determines the basic Function Selects "Safe Action" option

		0=S.Action 1=S.Capt. 2=DigEdge 3=An Edge  <b>Level "B"</b> 0=4:3 1=16:9 2=16p4:3 3=16p149 4=43p16:9  <b>Level "C"</b> 0=Thin 1=Thick 2=Shade 3=Black	Selects "Safe Caption" option Selects "Digital Edge" option Selects the "An. Edge" option  <u>Digipot B</u> Determines the Screen Format Standard 4:3 Screen Standard 16:9 Screen 16:9 Shoot to protect 4:3 16:9 Shoot to protect 14:9 4:3 Shoot to protect 16:9  <u>Digipot C</u> Determines the Style of Indicate Thin White lines are used Thick White lines are used Shade is used for "danger area" Black is used for "danger area"
78	Blank		
79	BACK	none	Go To the Utils submenu

**Menu 80-83: RGB Gamma values.**

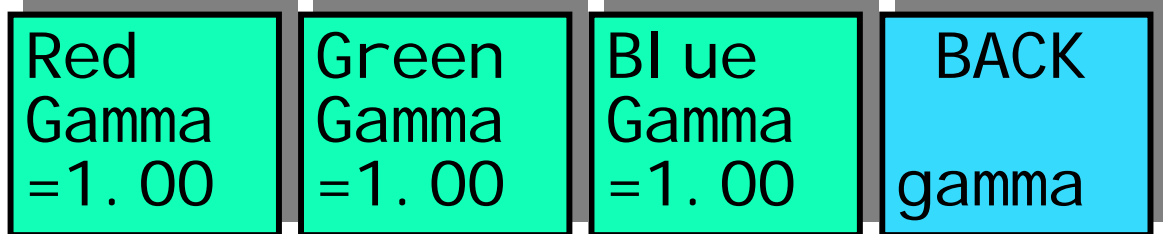

Menu Num.	Heading	Automation	Function
80	Red Gamma	0x28→0x1fff	This option sets the Red Gamma. The action depends on menu#85.
81	Green Gamma	0x28→0x1fff	This option sets the Green Gamma. The action depends on menu#85.
82	Blue Gamma	0x28→0x1fff	This option sets the Blue Gamma. The action depends on menu#85.
83	Back	N/A	Pressing this button will take the user back to the main menu

**Menu 84-87: RGB Gamma values.**

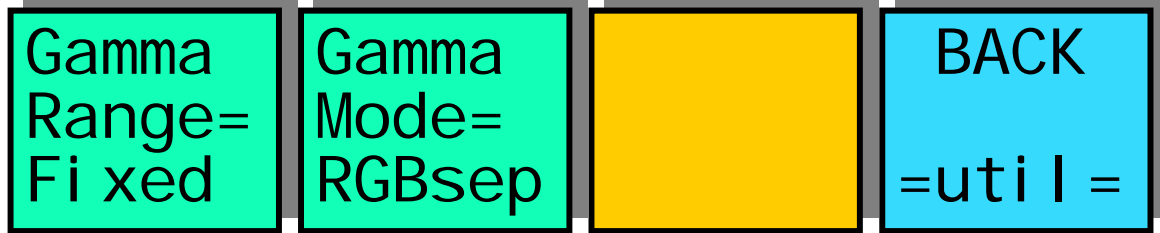

Menu Num.	Heading	Automation	Function
84	Gamma Range	0=Full,1=Fixed Default is Fixed	Pressing this will select whether the gamma function acts over the entire range (0-1023) or has two fixed points (64,940). The latter is the normal mode of operation.
85	Gamma mode	0=Ganged 1=RGB Separate	In Ganged mode the RGB Gamma controls in menus#80→82 act together (track) as a master gamma. In RGBsep mode, the RG and B gamma can be individually adjusted.
86	Blue Gamma	0x28→0x1fff	This option sets the Blue Gamma. The action depends on menu#85.
87	Back	N/A	Pressing this button will take the user back to the main menu